

marantz®

Model CD5400 User Guide

Compact Disc Player

CLASS 1 LASER PRODUCT
LUOKAN 1 LASERLAITE
KLASS 1 LASERAPPARAT

COMPACT
disc
DIGITAL AUDIO
TEXT

ENGLISH

WARRANTY

For warranty information, contact your local Marantz distributor.

RETAIN YOUR PURCHASE RECEIPT

Your purchase receipt is your permanent record of a valuable purchase. It should be kept in a safe place to be referred to as necessary for insurance purposes or when corresponding with Marantz.

IMPORTANT

When seeking warranty service, it is the responsibility of the consumer to establish proof and date of purchase. Your purchase receipt or invoice is adequate for such proof.

FOR U.K. ONLY

This undertaking is in addition to a consumer's statutory rights and does not affect those rights in any way.

FRANÇAIS

GARANTIE

Pour des informations sur la garantie, contacter le distributeur local Marantz.

CONSERVER L'ATTESTATION D'ACHAT

L'attestation d'achat est la preuve permanente d'un achat de valeur. La conserver en lieu sûr pour s'y reporter aux fins d'obtention d'une couverture d'assurance ou dans le cadre de correspondances avec Marantz.

IMPORTANT

Pour l'obtention d'un service couvert par la garantie, il incombe au client d'établir la preuve de l'achat et d'en corroborer la date. Le reçu ou la facture constituent des preuves suffisantes.

DEUTSCH

GARANTIE

Bei Garantiefragen wenden Sie sich bitte an Ihren Marantz-Händler.

HEBEN SIE IHRE QUITTING GUT AUF

Die Quittung dient Ihnen als bleibende Unterlage für Ihren wertvollen Einkauf. Das Aufbewahren der Quittung ist wichtig, da die darin enthaltenen Angaben für Versicherungswecke oder bei Korrespondenz mit Marantz angeführt werden müssen.

WICHTIG!

Bei Garantiefragen muß der Kunde eine Kaufunterlage mit Kaufdatum vorlegen. Ihren Quittung oder Rechnung ist als Unterlage ausreichend.

NEDERLANDS

GARANTIE

Voor inlichtingen omtrent garantie dient u zich tot uw plaatselijke Marantz.

UW KWITANTIE, KASSABON E.D. BEWAREN

Uw kwitantie, kassabon e.d. vormen uw bewijs van aankoop van een waardevol artikel en dienen op een veilige plaats bewaard te worden voor evt. verwijzing bijv. in verbend met verzekering of bij correspondentie met Marantz.

BELANGRIJK

Bij een evt. beroep op de garantie is het de verantwoordelijkheid van de consument een gedateerd bewijs van aankoop te tonen. Uw kassabon of factuur zijn voldoende bewijs.

ESPAÑOL

GARANTIA

Para obtener información acerca de la garantía póngase en contacto con su distribuidor Marantz.

GUARDE SU RECIBO DE COMPRA

Su recibo de compra es su prueba permanente de haber adquirido un aparato de valor. Este recibo deberá guardarlo en un lugar seguro y utilizarlo como referencia cuando tenga que hacer uso del seguro o se ponga en contacto con Marantz.

IMPORTANTE

Cuando solicite el servicio otorgado por la garantía el usuario tiene la responsabilidad de demostrar cuándo efectuó la compra. En este caso, su recibo de compra será la prueba apropiada.

ITALIANO

GARANZIA

L'apparecchio è coperto da una garanzia di buon funzionamento della durata di un anno, o del periodo previsto dalla legge, a partire dalla data di acquisto comprovata da un documento attestante il nominativo del Rivenditore e la data di vendita. La garanzia sarà prestata con la sostituzione o la riparazione gratuita delle parti difettose.

Non sono coperti da garanzia difetti derivanti da uso improprio, errata installazione, manutenzione effettuata da personale non autorizzato o, comunque, da circostanze che non possano riferirsi a difetti di funzionamento dell'apparecchio. Sono inoltre esclusi dalla garanzia gli interventi inerenti l'installazione e l'allacciamento agli impianti di alimentazione.

Gli apparecchi verranno riparati presso i nostri Centri di Assistenza Autorizzati. Le spese ed i rischi di trasporto sono a carico del cliente.

La casa costruttrice declina ogni responsabilità per danni diretti o indiretti provocati dalla inosservanza delle prescrizioni di installazione, uso e manutenzione dettagliate nel presente manuale o per guasti dovuti ad uso continuato a fini professionali.

PORTUGUÊS

GARANTIA

Para informações sobre a garantia, contactar o distribuidor Marantz local.

GUARDAR O RECIBO DE COMPRA

O recibo é o registo permanente da compra que fez. Deve ser guardado num local seguro, para ser apresentado em questões relacionadas com o seguro ou para quando tiver de contactar a Marantz.

IMPORTANTE

Quando procurar assistência técnica ao abrigo da garantia, é da responsabilidade do consumidor estabelecer a prova e data de compra. O recibo é prova adequada.

SVENSKA

GARANTI

För information om garantin, kontakta Marantz lokalagent.

SPAR KVITTOT

Kvittot är ett inköpsbevis på en värdefull vara. Det skall förvaras säkert och hänvisas till vid försäkringsfall eller vidkorrespondens med Marantz.

VIKTIGT

Fö att garantin skall gälla är det kundens sak att framställa bevis och datum om köpet. Kvitto eller faktura är tillräckligt bevis för detta.

DANSK

GARANTI

Henvend dem til Deres MARANTZ-forhandler angående information om garantien.

GEM DERES KVITTERING

Deres købskvittering er Deres varige bevis på et dyrt køb. Den bør gemmes godt og anvendes som bevis, hvis De vil tegne en forsikring, eller hvis De kommunikerer med Marantz.

VIGTIGT

Det påhviler forbrugeren at skaffe bevis for købet og købsdatoen, hvis han eller hun ønsker garantiservice. Deres købskvittering eller faktura er et fuldgældigt bevis herpå.

FOREWORD

This section must be read before any connection is made to the mains supply.

WARNINGS

- Do not expose the equipment to rain or moisture.
- Do not remove the cover from the equipment.
- Do not insert anything into the equipment through the ventilation holes.
- Do not handle the mains lead with wet hands.
- Do not cover the ventilation with any items such as tablecloths, newspapers, curtains, etc.
- No naked flame sources, such as lighted candles, should be placed on the equipment.
- When disposing of used batteries, please comply with governmental regulations or environmental public instruction's rules that apply in your country or area.

CE marking

CE The CD5400 conforms with the EMC directive and low-voltage directive.

EQUIPMENT MAINS WORKING SETTING

Your Marantz product complies with the household power and safety requirements in your area.

This product can be powered by 230 V AC only.

COPYRIGHT

Recording and playback of any material may require consent. For further information refer to the following:

- Copyright Act 1956
- Dramatic and Musical Performers Act 1958
- Performers Protection Acts 1963 and 1972
- any subsequent statutory enactments and orders

INTRODUCTION

Thank you for selecting the Marantz CD5400 CD Player for your A / V system.

This Compact Disc Player incorporates a number of features designed to enhance the listening of your favorite audio sources. Please read these operating instructions carefully. We recommend that you read the entire user guide before you attempt to connect or operate the player.

After you have reviewed the contents of this manual, we suggest that you make all system connections before you attempt to operate the unit.

INSTALLATION

Remember the following important points when installing the player:

- Do not expose the player to rain or moisture, as this may cause damage to the player.
- All players produce some heat during operation and this heat must be allowed to disperse freely. Do not close any ventilation openings and insure that there is adequate ventilation space behind, beside and above the player.
- Prevent extra heat from reaching the unit. Never put the player in the full glare of the sun or near a heat source.

PRECAUTIONS

The following precautions should be taken when operating the equipment.

GENERAL PRECAUTIONS

When installing the equipment ensure that:

- the ventilation holes are not covered.
- air is allowed to circulate freely around the equipment.
- it is placed on a vibration-free surface.
- it will not be exposed to excessive heat, cold, moisture or dust.
- it will not be exposed to direct sunlight.
- it will not be exposed to electrostatic discharges.

In addition, never place heavy objects on the equipment.

If a foreign object or water does enter the equipment, contact your nearest dealer or service center.

Do not pull out the plug by pulling on the mains lead; grasp the plug. It is advisable when leaving the house for an extended period, or during a thunderstorm, to disconnect the equipment from the mains supply.

PRECAUTIONS IN CONNECTION

- Be sure to unplug the power cable from the AC outlet or turn off the POWER switch before proceeding with any connection.
- Connect one cable at a time observing the "input" and "output". This will avoid any cross connection between channels and signal inputs and outputs.
- Insert the plugs securely. Incomplete connection may result in noise.
- Prior to connecting other audio equipment to the CD5400, please read their owner's manuals.

1. BEFORE USING	3
2. ACCESSORIES	5
3. FEATURES	6
4. CONNECTIONS	7
5. NAMES AND FUNCTIONS	8
Front panel	8
Display	9
Remote control unit	10
Rear panel	11
6. BASIC OPERATIONS	12
Playing CDs	12
Playing a specific track	13
Playing a specific part of a specific track	14
7. ADVANCED OPERATIONS	15
Repeat play (playing the same tracks repeatedly)	15
Random play (playing tracks in a random sequence)	16
AMS play (searching for a specific track)	16
Program play (playing tracks in the preferred sequence)	17
Delete program play (play with undesired tracks skipped)	19
Peak search (searching for the loudest passage)	22
Editing (recording a disc on a tape)	22
Pitch control (changing the play speed)	25
8. OTHER FUNCTIONS	26
CD-TEXT	26
9. SPECIFICATIONS AND DIMENSIONS	27
Specifications	27
Dimensions (unit: mm)	27
10. TROUBLESHOOTING	28

1. BEFORE USING

Notes about the discs

* **Handle the discs carefully so as not to scratch their surfaces.**

* **Keep the surfaces of the discs clean at all times.**

When cleaning the surfaces of discs, always be sure to use the special cleaner and wipe the surfaces in the directions shown in the figure below.

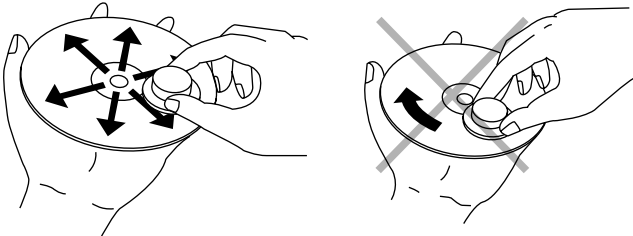

- Wipe the surface radially from the center.
- Do not wipe the surface in the circumferential direction.

* **Do not attach pieces of paper or stickers to the label surfaces of the discs.**

When a disc has a piece of plastic tape or rental CD label with paste protruding from the edge or when a disc still bears traces of sticky tape or adhesive labels, do not attempt to play it. If such a disc is played on the CD player, you may find that you cannot remove it or that some other kind of malfunctioning may occur.

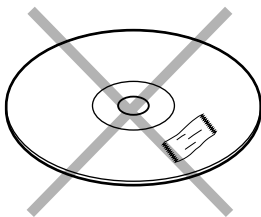

* **Do not use discs which come in special shapes.**

Do not attempt to play heart-shaped or octagonal discs or discs with any other special shapes. You may find that you cannot remove them or that some other kind of malfunctioning may occur in the player.

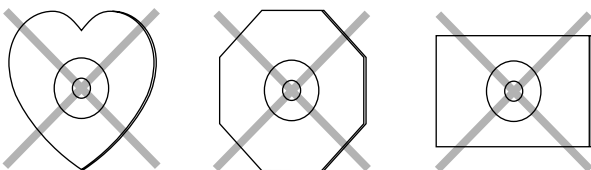

* **Use discs which satisfy the CD standards such as those with the "CD logo", "compact disc" or "compact disc digital audio" mark on their disc label surfaces.**

No guarantees are made for playback if discs which do not satisfy the appropriate CD standards are used. Similarly, no guarantees are made for their sound quality even if it is possible to play such discs.

* **To protect your discs from damage, avoid placing them in the following locations.**

- Where they will be exposed to direct sunlight or where they will be close to a heater or other heat-radiating appliance
- Where the humidity level is high or it is very dusty
- Near a window or other such location where they may be exposed to rain

* **Get into the habit of putting the discs back in their cases after use.**

Inappropriate places for installation

To keep your player in perfect working order for the longest possible time, avoid installing the player in the following locations.

- Wherever it will be exposed to direct sunlight
- Wherever it will be close to a heater or other heat-radiating appliance
- Wherever the humidity is high or ventilation is poor
- Wherever it is very dusty
- Wherever it will be subject to vibration
- On top of a rickety stand or in an unstable location which is tilted at an angle
- On top of an amplifier or other component which dissipates a great deal of heat
- In an audio rack with little space at the top and bottom or other location where the heat dissipation will be obstructed
To ensure proper heat dissipation, install the player while leaving clearances between the player and wall or other components, as shown in the figure below.

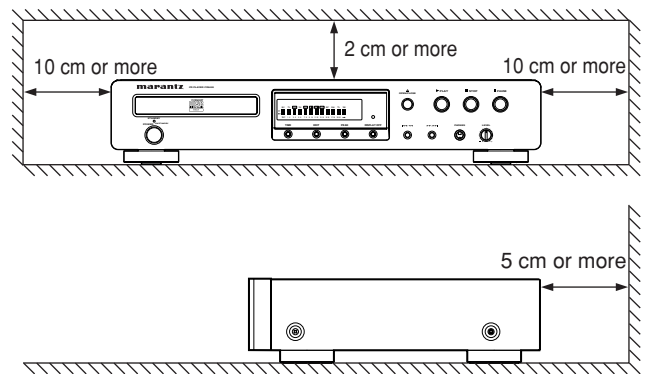

About playing copy-controlled CDs

Some copy-controlled CDs may not conform to official CD standards. They are special discs and may not play on the CD5400.

Do not place objects on top

- Refrain from placing any objects on top of the player.

Cautions on handling power cord

- Do not touch the power cord with wet hands.
- When disconnecting the power cord, always make sure that you take hold of the plug. Yanking out or bending the cord can damage it and/or cause electric shocks or a fire.
- Get into the habit of disconnecting the power plug before leaving home.

Do not attempt repairs yourself

- Refrain from lubricating the player: doing so can cause malfunctioning.
- Only qualified engineers with specialized expertise are authorized to repair the pick-up and parts inside the player.

Precautions

- In winter, droplets of water form on the insides of the windows of a heated room: this is called condensation. This CD player uses an optical lens, so the condensation may form in the following cases.
 - In a room immediately after the heating has been turned on
 - In a room where the humidity level is high
 - When the player has been suddenly brought from a cold location into a warm roomSince, in cases like this, the track numbers may not be read and the player is prevented from operating properly, wait about 30 minutes, and then operate the player.
- This player may cause interference on a tuner or TV set. If this is the case, place it further away from the tuner or TV set.
- Compact discs have much less noise than analog records and hardly any noise is heard before play starts. Bear in mind, therefore, that if the volume control on the amplifier is set too high, you will risk damaging other audio components.
- This player is designed to play music CDs only. It cannot play CD-ROMs used with personal computers, game CDs, video CDs or DVDs (video/audio).

Cautions on handling batteries

Misuse of the batteries can result in electrolyte leakage, rupturing, corrosion, etc.

Bear in mind the following points when using batteries.

- Remove the batteries from the remote control unit if the unit is not going to be used for a prolonged period (a month or more).
- Do not use an old battery together with a new one.
- Insert the batteries while ensuring that their \oplus and \ominus poles are properly aligned with the corresponding markings on the remote control unit.
- Batteries with the same shape may have different voltages. Do not use different types of batteries together.
- If electrolyte has leaked, thoroughly wipe the inside of the battery compartment, and then insert new batteries.

2. ACCESSORIES

Checking the accessories

After opening the cover of the packing box, check that the following accessories are included.

- **Remote control unit (RC5400CD)**

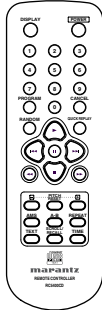

- **Size “AAA” batteries x 2**

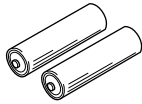

- **Audio connecting cord**

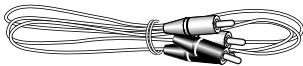

- **Remote control connecting cord**

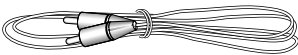

- **User Guide**

- **Registration Card**

- **Operational range**

As shown in the figure below, the player can be operated by the remote control unit in a range which of about 5 meters from the player's remote sensor and over an angle up to 30 degrees to the left and 30 degrees to the right of the position directly in front.

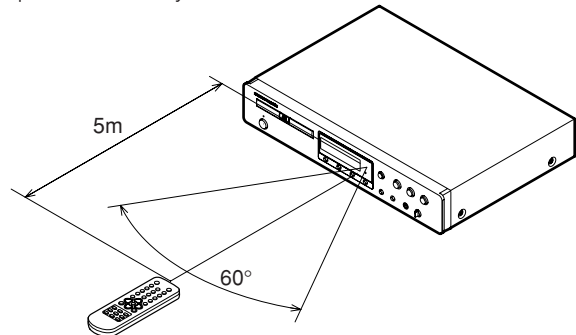

- **Loading batteries**

Before using the supplied remote control unit for the first time, load the batteries in the remote control unit. The batteries provided are used to verify the operations of the remote control unit only.

- 1 Take hold of the tab on the battery cover which is found on the back side of the remote control unit, and pull it up.

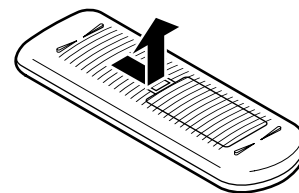

- 2 Load the two new size “AAA” batteries inside the battery compartment while taking care to align their polarities correctly with the polarity markings (\oplus with \oplus and \ominus with \ominus).

Size “AAA” (SUM-4) batteries x 2

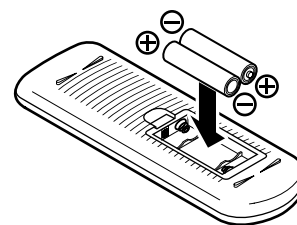

- 3 Push the battery cover down in the direction of the arrow to close it.

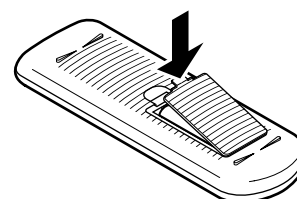

Usage of REMOTE CONTROL UNIT

- **Precautions**

- Do not allow direct sunlight, an inverter fluorescent light or other strong source of light to shine onto the player's infrared signal reception window (remote sensor). Otherwise, the operation of the remote control unit may be disabled.
- Bear in mind that operating the remote control unit may cause other devices operated by infrared rays to be operated by mistake.
- The remote control unit cannot be operated if the space between the controller and the player's remote sensor is obstructed.
- Do not place any objects on top of the remote control unit. Doing so may cause one or more buttons to be held down which will cause the batteries to run down.

3. FEATURES

- **CS4392 high-performance D/A converter made by Cirrus Logic used**

The CS4392 D/A converter whose CD playback circuitry has the same design as the CS4396 D/A converter, which was also made by Cirrus Logic and which has proved to be a valuable asset for the Marantz CD player, has been adopted.

During CD play, the PCM signals recorded on the disc are oversampled to 128fs inside the D/A converter and then processed by a combination of the dynamic element matching (DEM) and multi-element switched capacitors to achieve playback characterized by a high linearity.

This new CD playback technology opens the door to new dimensions in high-sound-quality CD play.

- **Display OFF function incorporated**

The “display OFF” function enables the main unit display to be turned off. By turning off this display, the pulsive noise generated from the display is reduced, thus eliminating its effects on the music signals.

- **Pitch control function**

The “pitch control” function enables the play speed (pitch) to be varied over a ± 12 step. This feature is particularly useful for musical instrument practice sessions.

- **Quick replay function**

By a single-action operation, the “quick replay” function enables play to be moved back from the current play position for 10 seconds and play to be resumed.

This function makes it possible to return to a part of the track that was just played so it can be heard again.

- **CD-TEXT display supported**

4. CONNECTIONS

This CD player is connected to an amplifier, CD recorder and other components for use. To ensure that the components are connected properly, refer to the instruction manuals that come with the components to be connected. Before connecting the components, be absolutely sure to turn off their power.

Connecting to an amplifier

Use the audio connecting cord to connect the player with a stereo amplifier or AV amplifier. Do not connect the player to the PHONO input connectors on the amplifier. When making the connections, insert the plugs securely into the connectors. Failure to insert the plugs securely may result in noise.

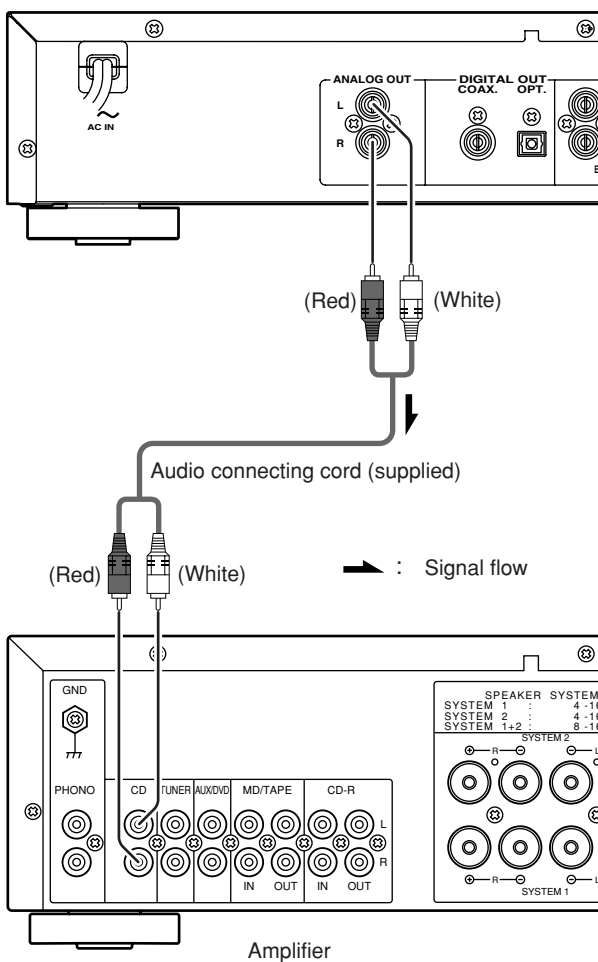

Connecting to a digital audio component

The player has one digital optical output connector and one digital coaxial output connector. You can enjoy digital recording when the player is connected to a CD recorder or other digital recording component.

Connecting the optical output connector

Use an optical digital connecting cable available on the market. Insert the plug firmly in until it clicks into place. Do not bend or bundle the optical digital connecting cable.

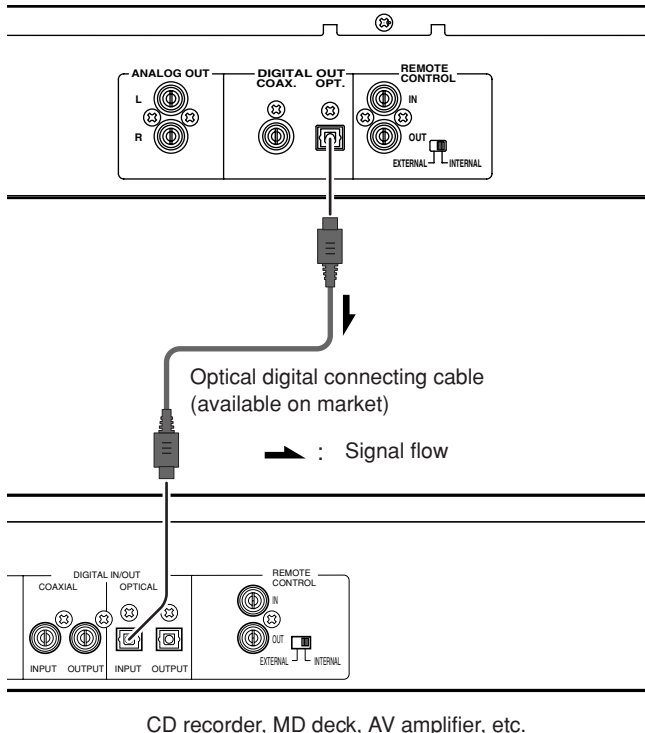

Connecting the coaxial output connector

Use a coaxial digital connecting cable available on the market.

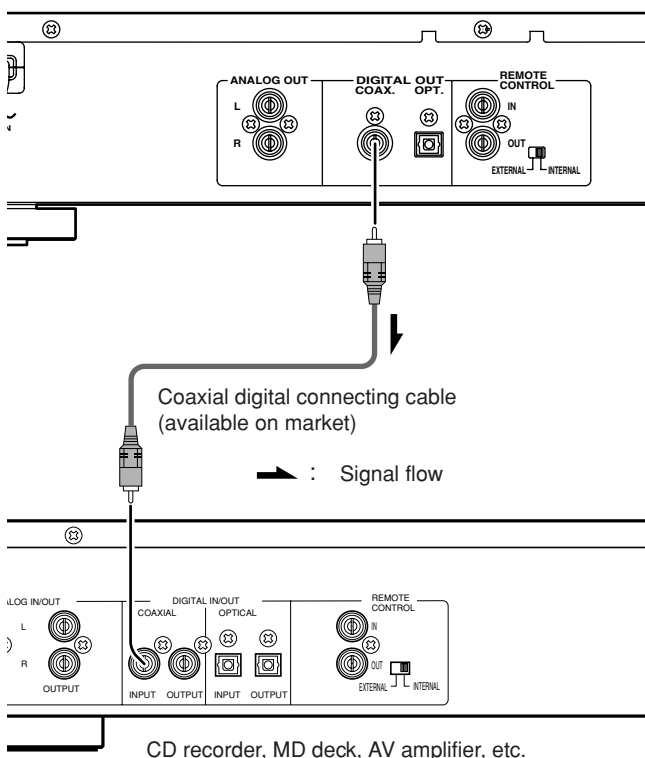

5. NAMES AND FUNCTIONS

Front panel

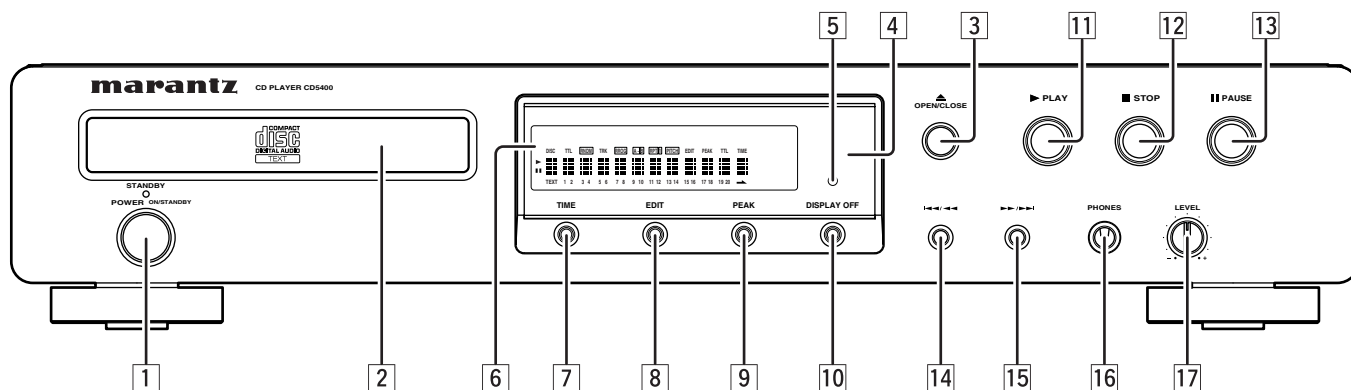

1 POWER ON/STANDBY switch and Standby indicator

This is used to turn the player's power ON and STANDBY. When it is pressed, the display lights and the power is turned on; when it is pressed again, the power is turned off and STANDBY indicator lights.

2 Disc tray

This is where the CD to be played is placed.

3 OPEN/CLOSE ▲ button

This is used to open and close the disc tray. When it is pressed, the disc tray opens; when it is pressed again, it closes.

4 Remote sensor

This senses the infrared control signals sent from the remote control unit.

5 DISPLAY OFF indicator

This lights in the DISPLAY OFF mode (when the display is off).

6 Display

This shows the settings, play status, text information, etc.

7 TIME button

Switches the time shown on the display to the remaining time of the current track or the remaining time of the entire disc.

With a CD-TEXT disc, this switch is also used to switch the displayed information from the text display mode to the time display mode.

8 EDIT button

Press to engage the editing function, which helps record a disc onto a tape by playing the tracks according to the tape length and leaving a nonrecorded blank of 4 seconds between every track.

9 PEAK button

When the PEAK button is pressed, searching for the loudest passage (peak) on a CD or in a program.

10 DISPLAY OFF button

This is used to turn off the display (DISPLAY OFF mode). When it is pressed, the display is turned off; when it is pressed again, the display comes on.

11 PLAY ► button

This is used to start play.

12 STOP ■ button

This is used to stop play.

13 PAUSE || button

This is used to temporarily suspend play.

14 ◀◀/◀ (previous track/search backward) button

When this button is pressed, play returns to the start of the track now being played. The same number of tracks as the number of times the button is pressed can be skipped in the reverse direction. When the button is held down, tracks are searched (fast backward).

15 ▶▶/▶ (search forward/next track) button

The same number of tracks as the number of times the button is pressed are skipped in the forward direction. When the button is held down, tracks are searched (fast forward).

16 PHONES jack

The headphones are connected to this jack. Use headphones that come with a standard plug.

17 PHONES LEVEL control

This is used to adjust the headphones volume level. The level increases when it is turned clockwise.

Display

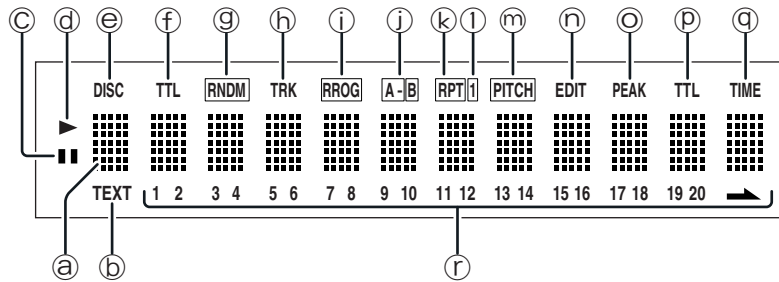

- a Main display**
This displays the time information and text information of the disc played, the setting menus, etc.
- b TEXT indicator**
This lights when a disc supporting CD-TEXT has been loaded.
- c || (pause) indicator**
This lights when play is temporarily suspended.
- d ► (play) indicator**
This lights during play.
- e DISC indicator**
This flashes during readout of the table of contents (TOC) information on the disc.
- f TTL (total track) indicator**
This lights above the display of the total number of tracks recorded on the disc.
- g RNDM (random) indicator**
This lights during random play.
- h TRK (track) indicator**
This lights above the display of the number of the track being played, etc.
- i PROG (program) indicator**
This lights during program play.
- j A-B (A-B repeat) indicator**
This lights during A-B repeat play.
- k RPT (repeat) indicator**
This lights during repeat play.
- l 1 (1-track repeat) indicator**
This lights during 1-track repeat play.
- m PITCH (pitch control) indicator**
This lights the pitch control setting.
- n EDIT indicator**
This lights during edit mode.
- o PEAK indicator**
This lights during peak search, and flashes during playback of the peak.
- p TTL (total time) indicator**
When the total remaining time or total program time is displayed, this lights above that display.
- q TIME indicator**
This lights while the elapsed time or other such time is displayed.
- r 1 - 20, ► (music calendar)**
This displays the track numbers recorded on the disc, the track numbers still to be played, and the track numbers programmed for program play.

Remote control unit

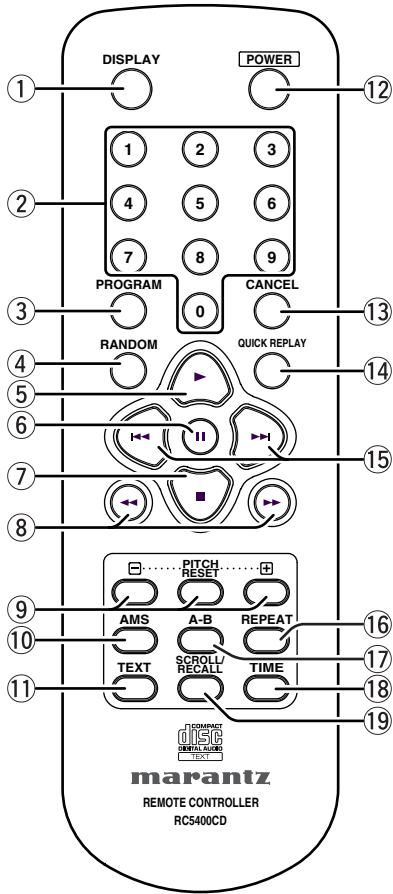

- ① **DISPLAY button**
This is used to turn off the display (DISPLAY OFF mode).
- ② **Numeric buttons (0 to 9)**
These are used to specify the numbers of the tracks to be played.
- ③ **PROGRAM button**
This is pressed to initiate program play.
- ④ **RANDOM button**
This is used to play the tracks in a random sequence.
- ⑤ **▶ (play) button**
This is used to start play.
- ⑥ **⏸ (pause) button**
This is used to temporarily suspend play.
- ⑦ **■ (stop) button**
This is used to stop the play.

- ⑧ **◀◀, ▶▶ (search) buttons**
◀◀ : This button is used to search backward when it is held down during play.
▶▶ : This button is used to search forward when it is held down during play.
- ⑨ **PITCH -/RESET/+ (pitch control down/reset/up) buttons**
These are used to adjust the play speed (pitch) with a ±12 step.
- ⑩ **AMS (auto music scan) button**
This is used to play the intros of all the tracks in sequence starting from the first track for the duration equivalent to the setting.
- ⑪ **TEXT button**
This is used to switch the main display from the time display to the text display.
- ⑫ **POWER button**
This is used to switch the player's power ON and STANDBY.
- ⑬ **CANCEL button**
This is used to cancel the programmed tracks.
- ⑭ **QUICK REPLAY button**
This is used to search backward from the current play position for 10 seconds and resume play.
- ⑮ **◀◀, ▶▶ (track skip) buttons**
◀◀ : Use this to return to the start of the track now playing or return to the start of the previous track.
▶▶ : Use this to advance to the start of the subsequent track.
- ⑯ **REPEAT button**
This is used to play one track or all the tracks on the disc repeatedly.
- ⑰ **A-B (A-B repeat) button**
This is used to set start point (A) and end point (B) when a particular section is to be played repeatedly.
- ⑱ **TIME button**
This switches the main display from the text display to the time display. It can also switch the time display during play. It can display how much time has elapsed and how much play time remains for the current track as well as how much play time remains for the whole disc.
- ⑲ **SCROLL/RECALL button**
This is used to scroll the text display when text is displayed. When it is pressed during program play, it is possible to check which tracks have been programmed.

Rear panel

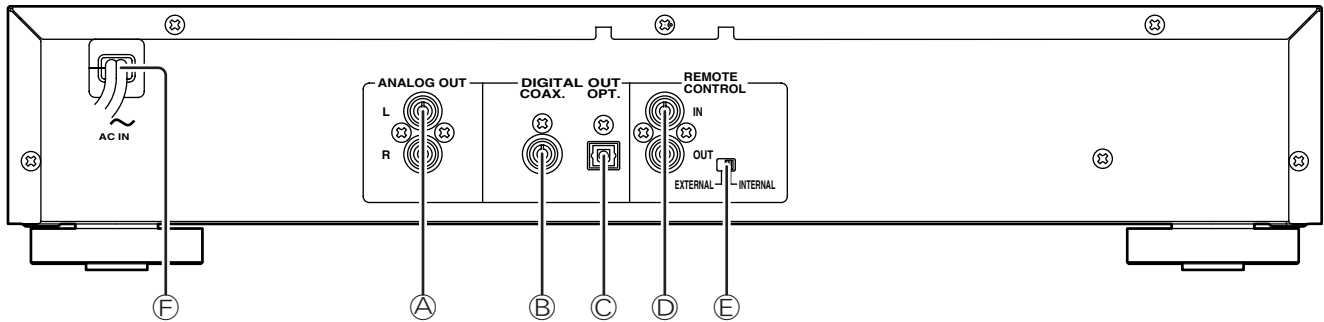

A ANALOG OUT (analog output) connectors

The music signals during play are output from these connectors.

B DIGITAL OUT COAX. (digital coaxial output) connector

The music signals during play are output digitally from this coaxial output connector.

* Digital signals are not output during pitch control play.

C DIGITAL OUT OPT. (digital optical output) connector

The music signals during play are output digitally from this optical output connector.

* Digital signals are not output during pitch control play.

D REMOTE CONTROL IN and OUT connectors

Using the supplied remote control connecting cable, these connectors enable this player to be connected to a Marantz component equipped with remote control connectors. These connections make it possible to control an entire system that centers on the amplifier or other such component.

E EXTERNAL/INTERNAL switch

Before the player was shipped from the factory, this switch was set to INTERNAL to enable the remote sensor built into the player to be used.

Before using the supplied connecting cable to make the connection between the player and the remote control connectors on a Marantz equipment, set the switch to EXTERNAL.

Note:

Signals cannot be received from the remote control unit if the switch is kept at EXTERNAL when the player is to be used on its own.

F AC POWER SOURCE CONNECTION

Plug the mains lead into a mains outlet providing the right voltage.

6. BASIC OPERATIONS

Playing CDs

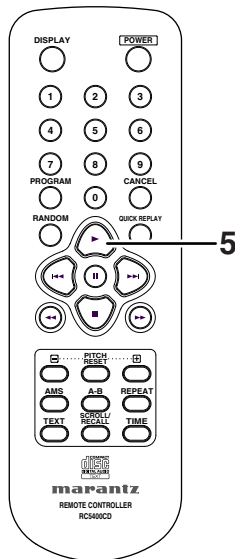
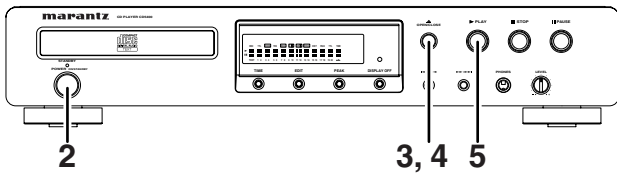

1. Turn on the power of the amplifier to which the player is connected, and use the input selector on the amplifier to select "CD" (the player's input source which has been connected).
2. Press the POWER button on the player to turn on the power.
3. Press the OPEN/CLOSE ▲ button on the player. Place the CD to be played in the extended disc tray while ensuring that the label with the printed text is facing up.

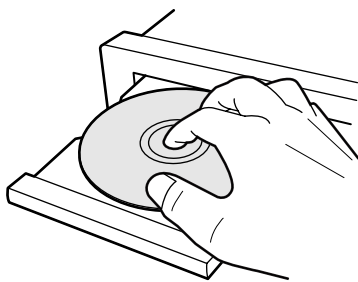

In the case of a single (8 cm) CD, align it with the indentation in the center of the tray.

4. Press the OPEN/CLOSE ▲ button on the player to retract the disc tray. Pushing the front of the disc tray lightly also causes the tray to be retracted. Once the disc tray has been retracted, "TOC Reading" appears on the display, after which the total number of CD tracks and total remaining time are displayed. In the case of a disc that supports CD-TEXT, the album title is displayed, and then the total number of CD tracks and total remaining time are displayed.
5. Press the ► button on the player or remote control unit to start play. Adjust the volume level at the amplifier.

• Stopping play

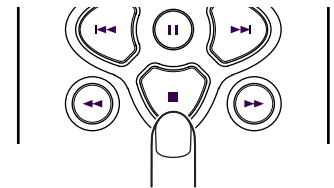
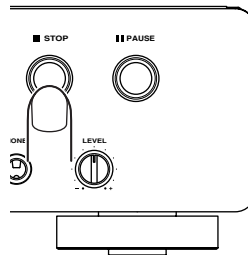

Press the ■ button on the player or remote control unit during play.

• Pausing play

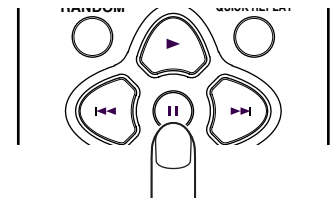
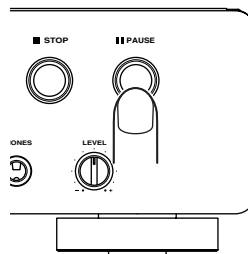

During play, press the || button on the player or remote control unit to temporarily suspend play.

To resume play from the place where it was temporarily suspended, press the ► button or || button on the player or the ► button or || button on the remote control unit.

• Removing the CD

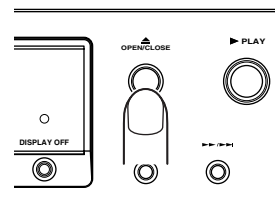

After play has finished, press the OPEN/CLOSE ▲ button on the player to extend the disc tray, and remove the CD.

After the CD has been removed, press the OPEN/CLOSE ▲ button again to retract the disc tray. The disc tray should always be retracted when the player is not in use.

Playing a specific track

- **Specifying the number of a track to be played (direct search)**

Select the number of the track to be played directly by pressing the numeric buttons (0 to 9) on the remote control unit. To select track number 10 or above, use the numeric buttons to select the higher digit first and then select the lower digit. Once the number of the track is selected, play will start automatically.

Example: To play track 3

Press the "3" numeric button.

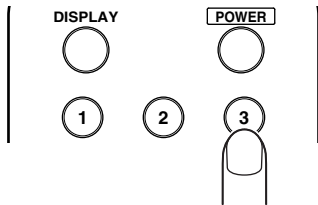

Example: To play track 12

Press the "1" numeric button.

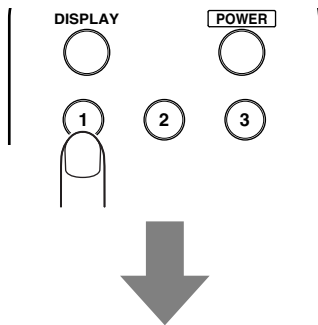

Within 1 second, press the "2" numeric button.

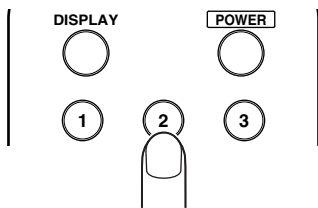

- **Playing a previous or subsequent track (track skip)**

Advancing to a subsequent track

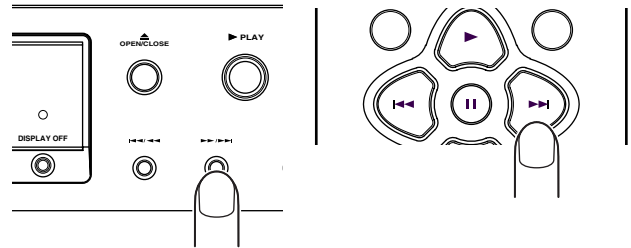

Press the ►►/►► button on the player or ►► button on the remote control unit for the number of times equivalent to the number of tracks through which play is to be advanced.

Returning to the start of the track now playing or a previous track

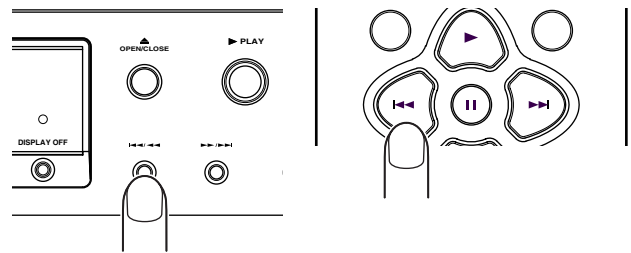

When the ◀◀/◀◀ button on the player or ◀◀ button on the remote control unit is pressed, play returns to the start of the track now playing. Play returns to the previous track which is equivalent to the number of times the button was pressed.

Playing a specific part of a specific track

- **Searching a specific part of a track (search)**

While listening to a track being played, it is possible to search a specific part of that track by a forward or backward search.

Forward searching through the track now playing

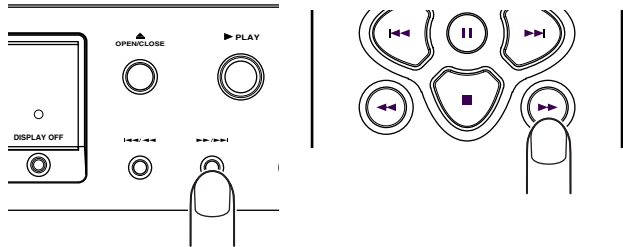

The search (forward search) mode is established by holding down the ►►/►► button on the player or ►► button on the remote control unit.

Holding down the button initiates a forward search.

Backward searching through the track now playing

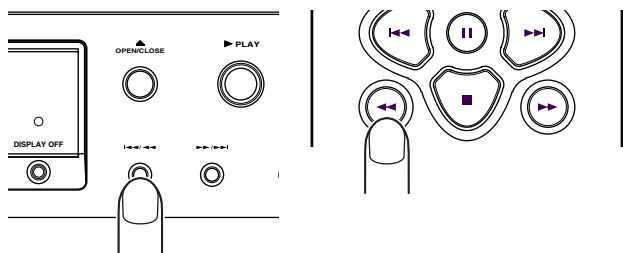

The search (backward search) mode is established by holding down the ◀◀/◀◀ button on the player or ◀◀ button on the remote control unit.

Holding down the button initiates a backward search. (Returns during backward searches are not constant.)

- **Playing the last 10 seconds again during play (quick replay)**

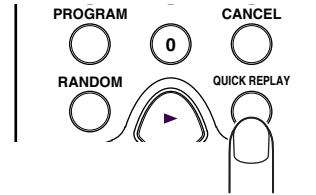

When the QUICK REPLAY button on the remote control unit is pressed during play, play will be returned by 10 seconds, and the same section will be played again.

7. ADVANCED OPERATIONS

Repeat play (playing the same tracks repeatedly)

• Playing all tracks repeatedly (all-track repeat)

This function repeatedly plays all the tracks. Repeat play is possible even during random play or program play.

Press the REPEAT button on the remote control unit.

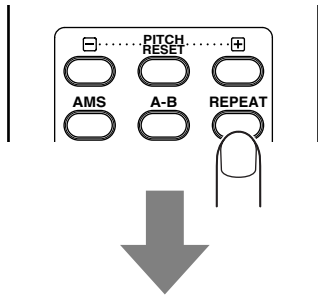

The "RPT" indicator on the display lights, and the repeat play of all the tracks starts.

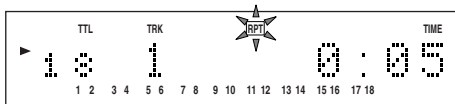

To stop all-track repeat play and resume normal play, press the REPEAT button on the remote control unit twice. The "RPT" indicator on the display goes off.

• Playing one track repeatedly (1-track repeat)

This function repeatedly plays one track only. Even during random play or program play, it repeats the track being played. Press the REPEAT button on the remote control unit twice while the track to be repeated is playing.

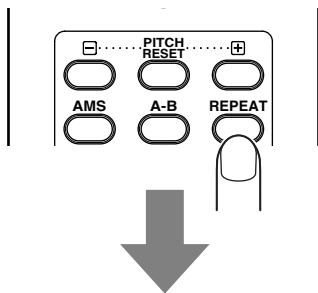

The "RPT" and "1" indicators light, and track now playing is repeated.

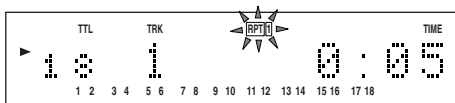

To stop 1-track repeat play and resume normal play, press the REPEAT button on the remote control unit to turn off the "RPT" indicator on the display.

• Playing a specific part repeatedly (A-B repeat)

This function repeatedly plays a specific part of a track that you want to hear.

1. During play, press the A-B button on the remote control unit at the start point of the part to be repeated.

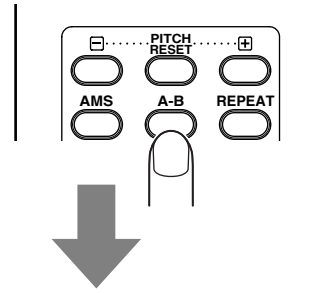

The "A-" indicator on the display now lights.

Display example: A-B repeat , point A (start), track 1, 5 sec.

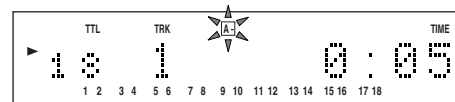

2. Press the A-B button on the remote control unit at the end point of the part to be repeated.

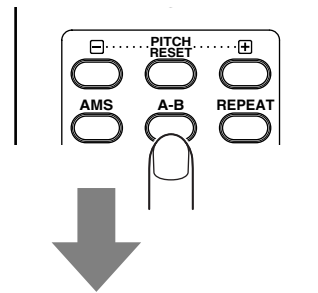

The "A-B" indicator on the display now lights, and the designated part (from point A to point B) is played repeatedly.

Display example: A-B repeat , point B (end), track 1, 20 sec.

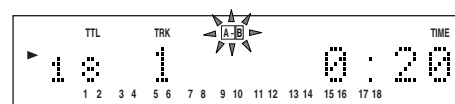

To stop A-B repeat play and resume normal play, press the A-B button on the remote control unit to turn off the "A-B" indicator on the display.

Note:

The A-B repeat play function cannot be used during random play.

Random play (playing tracks in a random sequence)

This function rearranges the tracks into a random sequence and it then plays all the tracks in this random sequence. If it is used together with repeat play, the same tracks can be repeatedly played but in a different sequence every time.

During play or stop, press the RANDOM button on the remote control unit.

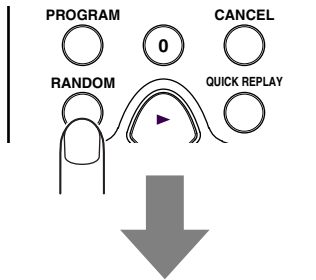

The items on the music calendar appear on the display one after the other, and the "RNDM" indicator lights.

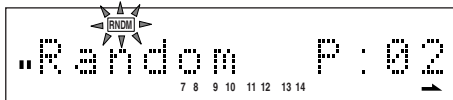

Random play now starts.

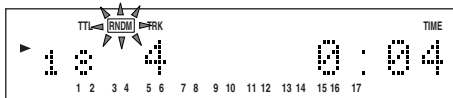

To stop random play and resume normal play, press the RANDOM button on the remote control unit. The "RNDM" indicator on the display goes off.

• Skipping tracks during random play to search other tracks

When the ►►/►► button on the player or ►► button on the remote control unit is pressed during random play, the next track is selected at random and played.

Conversely, when the ◀◀/◀◀ button on the player or ◀◀ button on the remote control unit is pressed during random play, play returns to the start of the track now playing. If the same operation is repeated, play is initiated in the reverse order in which the tracks were played.

AMS play (searching for a specific track)

This function comes in handy when searching for a specific track that you want to hear. You can choose whether to play 10, 20 or 30 seconds of each track.

During stop or play, press the AMS (auto music scan) button on the remote control unit.

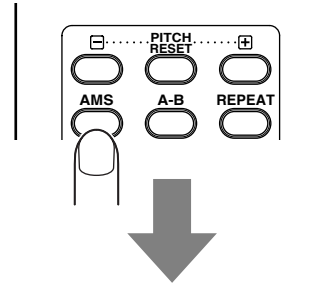

Press the AMS button repeatedly to switch through the different scan modes.

"Scan 10", "Scan 20", "Scan 30", "Scan Off"... (Scan Off aborts the scan function) light on the display, and the "►" indicator flashes.

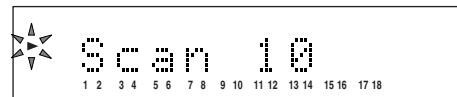

The intros of all the tracks starting from track 1 are played in succession for the duration which has been select.

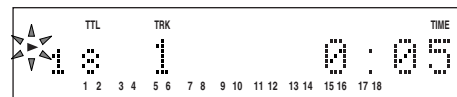

Once the track you want to hear has been found, press the ► button. The "►" indicator now lights, and the track found and whatever comes after that track will now be played normally. When the RANDOM button on the remote control unit is pressed during AMS play, the AMS play function is released, and the random play mode is established.

Program play (playing tracks in the preferred sequence)

The order in which the CD tracks are played can be rearranged into the sequence desired. Up to 30 tracks can be programmed.

• Program play in the time display mode

In the case of a CD-TEXT disc, first press the TIME button on the remote control unit to set the main display to the time display mode.

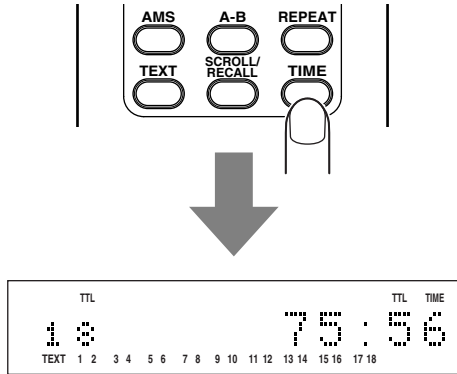

1. During stop, press the PROGRAM button on the remote control unit.

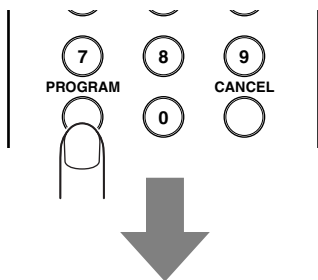

“Program” appears for an instant on the main display.



The PROG indicator flashes, and the program mode is established.

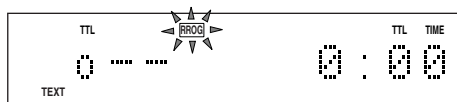

2. Press the numeric buttons on the remote control unit the tracks can also be selected using the ◀◀ and ▶▶ buttons on the remote control unit or ◀◀/◀◀ and ▶▶/▶▶ buttons on the player. To select track number 10 or above, use the numeric buttons to select the higher digit first and then select the lower digit.

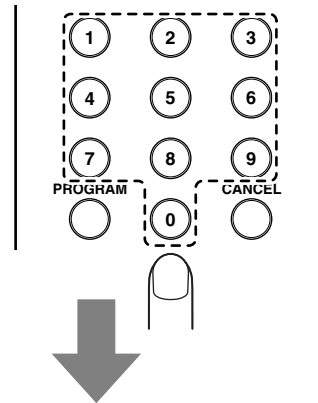

Display example: When track 2 has been selected

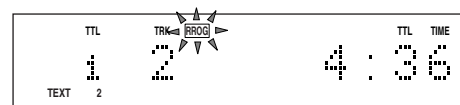

3. Repeat step 2 to program the desired tracks in sequence. At each step of the programming, the number of tracks programmed and their total time appear on the main display. Up to 30 tracks can be programmed.

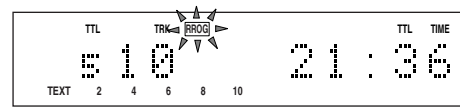

4. Once all the tracks have been programmed, press the ■ button on the player or remote control unit or press the PROGRAM button on the remote control unit.

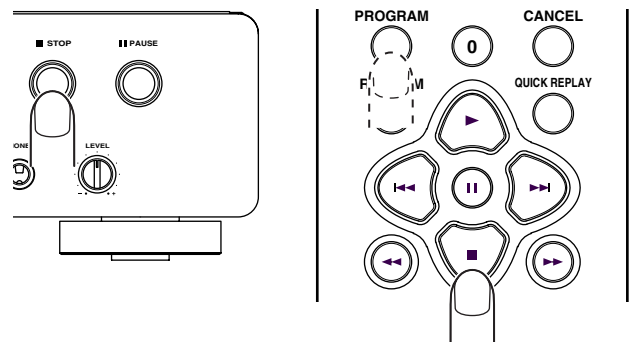

The PROG indicator stops flashing and lights up instead, and the program is entered.

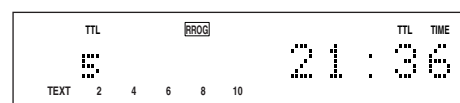

5. Press the ▶ button on the player or remote control unit. Play now starts in the programmed sequence. Program play will start even when step 4 is omitted.

• Program play in the text display mode

In the case of a CD-TEXT disc, tracks can be selected by title for program play.

If the main display is set to the time display mode, press the TEXT button on the remote control unit to establish the text display mode.

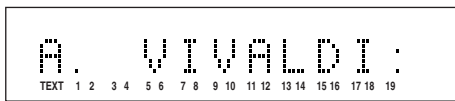
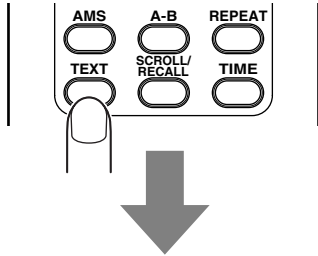

1. During stop, press the PROGRAM button on the remote control unit.

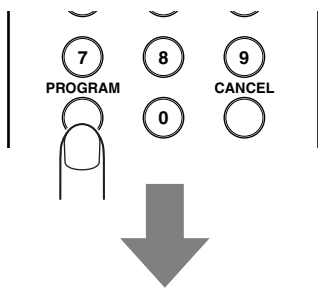

“Program” appears for an instant on the main display. Then the PROG indicator flashes, and the program mode is established.

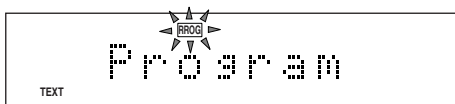

2. Press the ◀◀ and ▶▶ buttons on the remote control unit or ◀◀/◀◀ and ▶▶/▶▶ buttons on the player to select the track. (The track can also be selected using the numeric buttons on the remote control unit but in this case the title is not displayed).

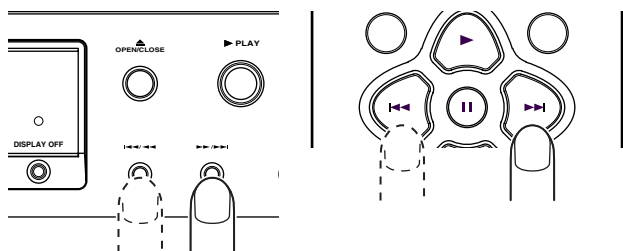

The title of each selected track is scrolled, and once it has been scrolled, it is programmed automatically. If you do not want to program the track, select another track before the scrolling is completed.

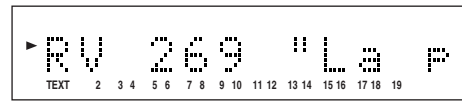

3. Repeat step 2 to program the desired tracks in sequence. Up to 30 tracks can be programmed.

4. Once all the tracks have been programmed, press the ■ button on the player or remote control unit or press the PROGRAM button on the remote control unit.

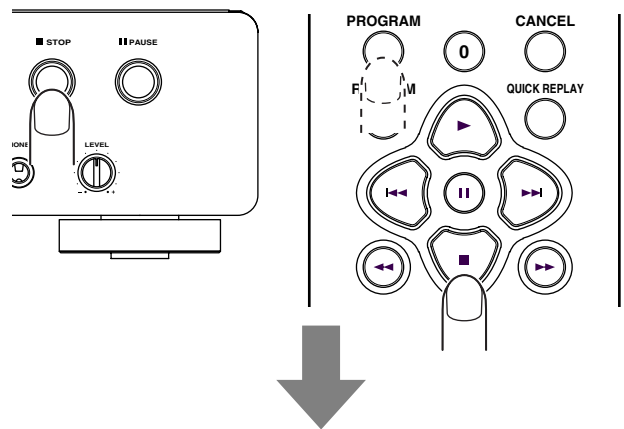

The PROG indicator stops flashing and lights up instead, and the program is entered.

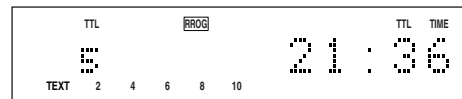

5. Press the ▶ button on the player or remote control unit. Play of the selected tracks now starts in the programmed sequence. Program play will start even when step 4 is omitted.

Note:

Programming in the text display mode cannot be performed for tracks which have no text information for their titles.

Delete program play (play with undesired tracks skipped)

This function makes it possible to skip those tracks that you do not want to hear during CD play. Up to 30 tracks can be deleted from the program.

• Delete program play in the time display mode

In the case of a CD-TEXT disc, first press the TIME button on the remote control unit to set the main display to the time display mode.

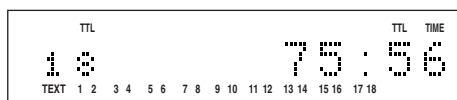
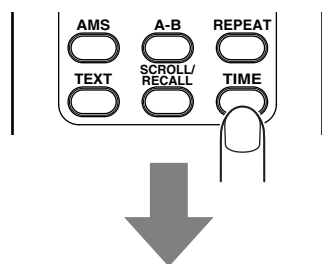

1. During stop, press the PROGRAM button on the remote control unit, and then press the CANCEL button.

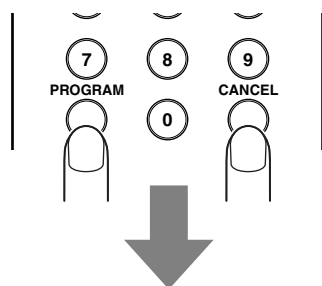

"Delete Prog." appears for an instant on the main display.

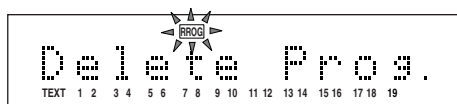

The total number of CD tracks and the total play time appear on the main display, the PROG indicator flashes, and the delete program mode is established.

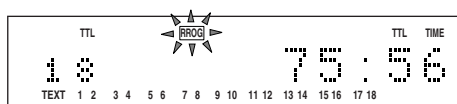

2. Press the numeric buttons on the remote control unit that you do not want to hear (the track can also be selected using the <<< and >>> buttons on the remote control unit or <<</>>> and >>>/<<< buttons on the player).

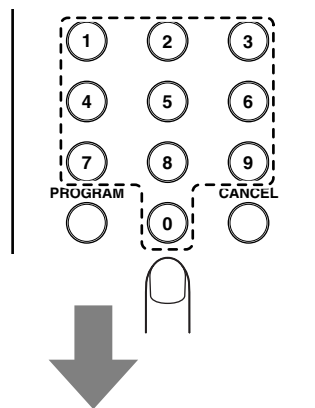

Display example: When track 2 has been selected

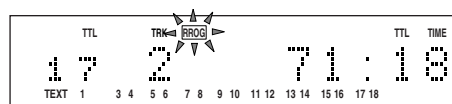

3. Repeat step 2, and upon completion of the programming, press the ■ button on the player or remote control unit or press the PROGRAM button on the remote control unit.

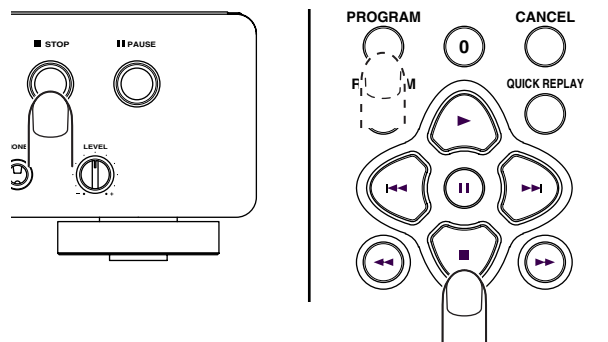

The PROG indicator in the display stops flashing and lights up instead, and the delete program is entered. Up to 30 tracks can be deleted from the program.

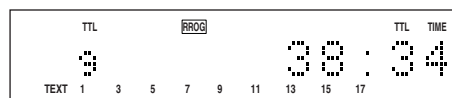

4. Press the ► button on the player or remote control unit. The CD is now played but with the deleted tracks skipped.

• Delete program play in the text display mode

In the case of a CD-TEXT disc, the tracks that are not desired can be selected by title for delete program play.

If the main display is set to the time display mode, press the TEXT button on the remote control unit to establish the text display mode.

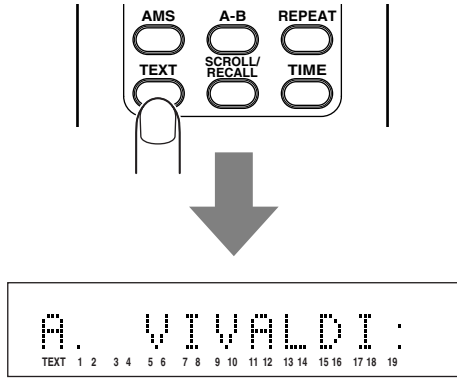

1. During stop, press the PROGRAM button on the remote control unit, and then press the CANCEL button.

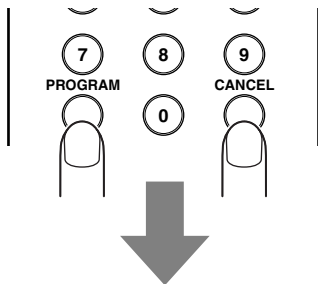

"Delete Prog." appears for an instant on the main display.

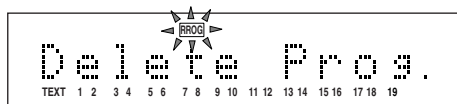

The total number of CD tracks and the album title appear on the main display, the PROG indicator flashes, and the delete program mode is established.

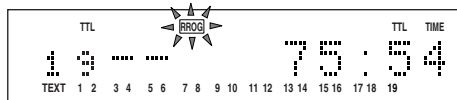

2. Press the ◀◀ and ▶▶ buttons on the remote control unit or ◀◀/◀◀ and ▶▶/▶▶ buttons on the player to select the track which you do not want to hear. (The tracks can also be selected using the numeric buttons on the remote control unit but in this case the titles will not be displayed.)

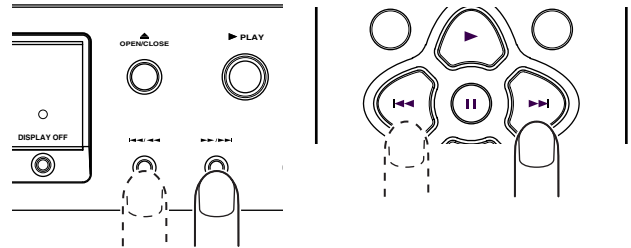

The title of each selected track is scrolled, and once it has been scrolled, it is deleted automatically. If you do not want to delete the track, select another track before the scrolling is completed.

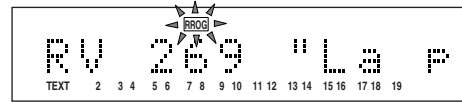

3. Repeat step 2, and upon completion of the programming, press the ■ button on the player or remote control unit or press the PROGRAM button on the remote control unit.

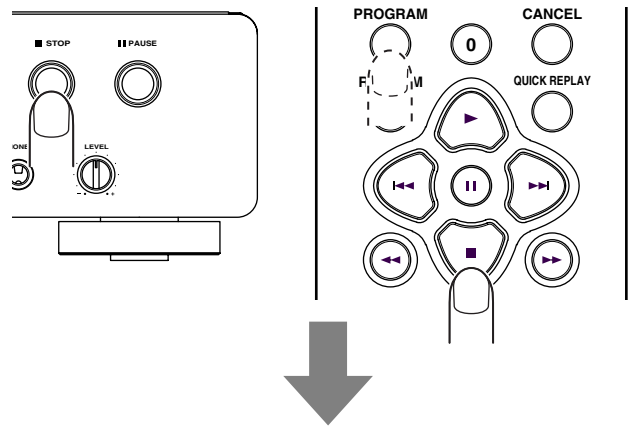

The PROG indicator in the display stops flashing and lights up instead, and the delete program is entered. Up to 30 tracks can be deleted from the program.

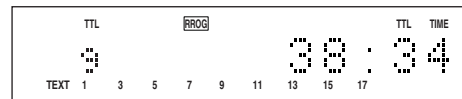

4. Press the ▶ button on the player or remote control unit. The CD is now played but with the deleted tracks skipped.

Note:

Delete programming in the text display mode cannot be performed for tracks which have no text information for their titles.

• **Checking the program or delete program contents**

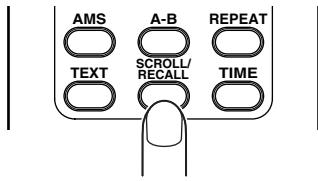

During programming operation or program play, press the SCROLL/RECALL button on the remote control unit. With program play, the programmed tracks are displayed one after the other in sequence on the main display. With delete program play, the deleted tracks are displayed one after the other in sequence on the main display.

• **Changing the program or delete program contents**

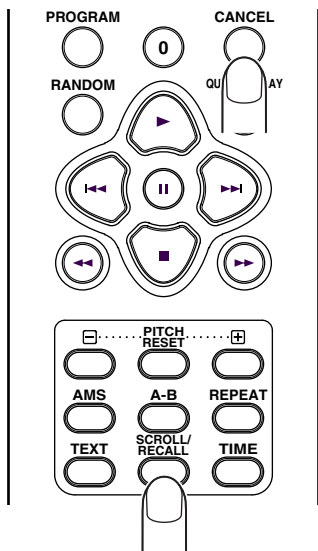

Deleting tracks which were programmed for program play

When the SCROLL/RECALL button on the remote control unit is pressed during programming, the programmed tracks are displayed one after the other in sequence. As soon as the track to be deleted from the program has appeared, press the CANCEL button on the remote control unit immediately. The number of the deleted track is cleared from the music calendar on the display.

Canceling the deletion of tracks which were deleted for delete program play

When the SCROLL/RECALL button on the remote control unit is pressed during delete programming, the deleted tracks are displayed one after the other in sequence. As soon as the track whose deletion is to be canceled has appeared, press the CANCEL button on the remote control unit immediately. The number of the track whose deletion was canceled is displayed in the music calendar on the display.

• **Returning program play to normal play (canceling the entire program)**

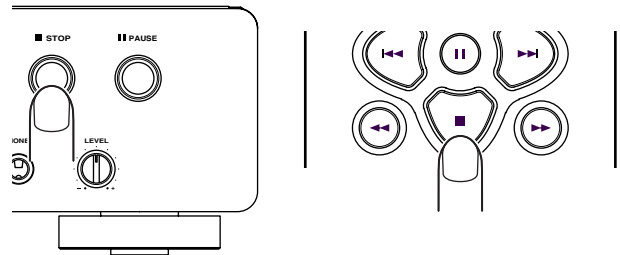

Press the ■ button on the player or remote control unit twice during program play or once during stop. The PROG indicator on the display goes off, and the entire program is canceled.

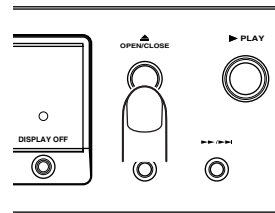

Alternatively, a program can be canceled when the disc tray is opened by pressing the OPEN/CLOSE ▲ button on the player.

Adding tracks to the program

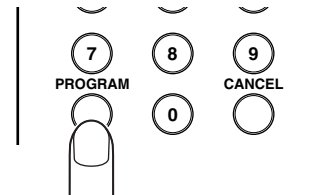

Press the PROGRAM button on the remote control unit during stop. The status of the PROG indicator in the display changes from lighted to flashing, and more tracks can be added to the program.

• **Precautions for program and delete program play**

- * When using the numeric buttons to select tracks 1 to 9 on a CD with 10 or more tracks in total, allow 1.5 seconds or so to elapse after the button corresponding to the number of the previous track was pressed before pressing the button corresponding to the number of the next track.
- * When using the numeric buttons to select track 10 or up on a CD with 10 or more tracks in total, press the button corresponding to lower digit within 1.5 seconds or so after the button corresponding to the higher digit was pressed.
- * When using the ◀◀ and ▶▶ buttons for programming, keep pressing one of these buttons with less than half a second or so in between until the number of the desired track is displayed.
- * If the total time for a program exceeds 99 minutes, the time display will appear as “-- : --.”

Peak search (searching for the loudest passage)

If the cassette deck recording level is adjusted in relation to the peak level on the disc, it is possible to avoid distortion and noise in recording. This facility allows the peak over the entire disc or in the programmed to be detected tracks before proceeding to editing.

1. Press the PEAK button on the player. "PEAK" will light up and the peak search operation will begin from the first passage on the disc. Searching may need a few minutes.

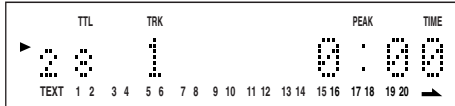

2. When peak search of the last passage is completed, play will be repeated for approximately 6 seconds with the volume at a comparatively high level. Adjust the record level of the cassette deck. (Please see the instruction manual for the cassette deck.)

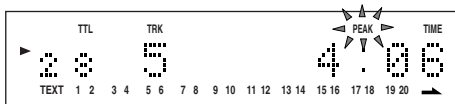

3. Press the ■ button on the player or remote control unit to stop the peak search operation.

Note:

As a CD may contain several peaks, a different peak may be found every time the auto peak level search operation is performed.

Editing (recording a disc on a tape)

When recording from a compact disc to a tape, use this function to match the tape length to the playing time of the tracks to be recorded and to create 4-second intervals between the tracks.

• Simple edit

This operation fits tracks into a specified tape length while keeping the tracks in their original order.

1. Press the EDIT button in stop mode to light up the EDIT indicator. (Example: When a disc with 28 tracks is loaded)

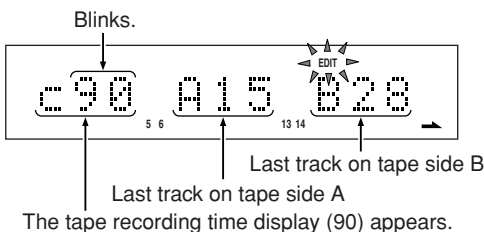
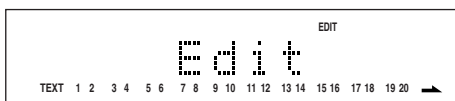

This example shows that, when the tape recording time is 90 minutes, track 15 is the last track on tape side A and track 28 the last track on tape side B. In other words, by using a 90-minute tape, all of the 28 disc tracks can be accommodated by assigning tracks 1 to 15 on tape side A and tracks 16 to 28 on tape side B.

2. To change the tape recording time, specify the new tape recording time using the ►► or ◀◀ button or the numeric buttons (0 to 9).

• Use of ►► and ◀◀ buttons

Each press of the ►► button allows you to change the recording time in the order 90 → 46 → 54 → 60 → 74 → 90. Each press of the ◀◀ button allows you to change the recording time in the order 90 → 74 → 60 → 54 → 46 → 90. Each press of the ►► button allows you to increase the recording time by 1 minute. Each press of the ◀◀ button allows to decrease the recording time by 1 minute.

- When numeric buttons are used to specify a C-46 tape, for example, press 4 then 6.

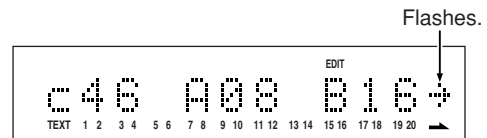

This display example shows that, with a 46-minute tape, tracks 1 to 8 will be recorded onto tape side A and tracks 9 to 16 will be recorded onto tape side B. The blinking arrow on the right end of the character display shows that tracks 17 and after cannot be recorded on the tape.

3. Press the EDIT button again and set the editing contents.

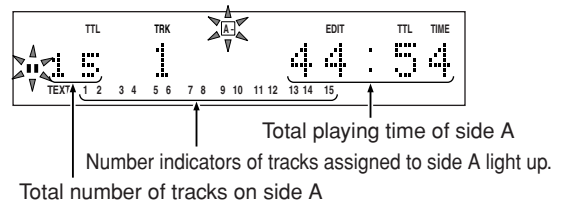

ADVANCED OPERATIONS

• Program edit

This procedure allows you to record tracks in any desired order while fitting the tracks into a specified tape length.

1. Program tracks according to the programming procedure in section "PROGRAM PLAY" (page 17).
2. The rest of the program edit procedure is the same as step 1 to 3 in the simple edit procedure.

• Delete program edit

When recording from a disc to a tape, this procedure allows you to omit the tracks you do not want to record, while fitting the tracks into a specified tape length.

1. Program tracks according to the "delete programming" procedure in the "PROGRAM PLAY" section (page 19).
2. The rest of the delete program edit procedure is the same as step 1 to 3 in the simple edit procedure.

Note:

- During the simple edit play, program edit play and delete program edit play, any operations other than the STOP, OPEN/CLOSE and TIME Display OFF buttons are disabled. This is intended to prevent mistakes in recording due to erroneous operation.
- While editing, remote control operations are disabled.
- The display is always in the time display mode during edit play. It is not possible to switch to the text display mode.

• Start Edit Recording

Before start editing, connect remote control input of Marantz cassette deck with remote control output of CD5400 by remote control cable.

Reverse mode switch may be set to any of one side (⇐), both sides (⇄) and continuous play (∞).

- Synchro recording with Marantz auto reverse cassette deck set to both sides (⇄) or continuous play (∞) mode.

1. After setting up, setup the cassette deck to rec pause state.
2. Press ► or || buttons of the player to start A side program. The player sends out signal to start recording and starts playing A side program after 4 seconds.

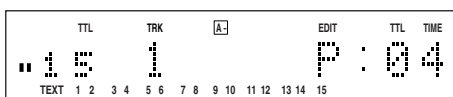
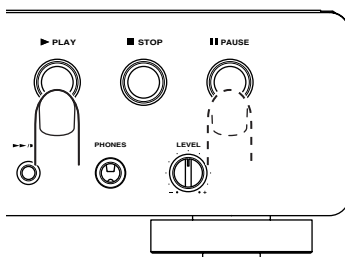

3. After A side program complete, player turns to the pause state at the beginning of B side program.

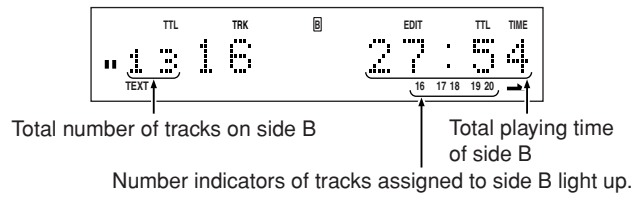

4. When A side of the tape ends up, cassette deck inverts its recording direction and set to rec pause state automatically.
5. Press ► or || buttons of the player manually to start B side recording. Player sends out signal to restart recording and starts playing B side program after 4 seconds.

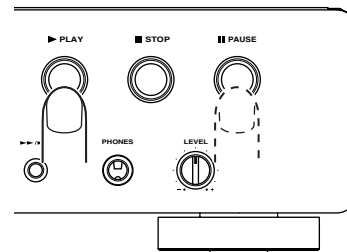

6. After B side program complete, player stops playing and clears edit program automatically.

Note:

- If the tape ends up before edit program of one side completes, for example by wrong tape length have chosen, cassette deck send out signal to player to let the player cancel the rest of program. Player jumps to the beginning of B side if it was A side or stop playing and clear edit program if it was B side.
- Synchro recording can be started only when a Marantz autoreverse cassette deck (ex. SD4050, SD555 etc.) with synchro recording compatibility is connected to the CD player.
- Synchro recording is performed through the remote line connection (rear panel jacks).

ADVANCED OPERATIONS

- **Synchro recording with Marantz one-way cassette deck, or Marantz auto reverse cassette deck set to one side ($\overline{\text{A}}$) mode.**

1. After setting up Edit program, setup the cassette deck to rec pause state.
2. Press **▶** or **⏸** buttons of the player to start A side program. The player sends out signal to start recording and starts playing A side program after 4 seconds.

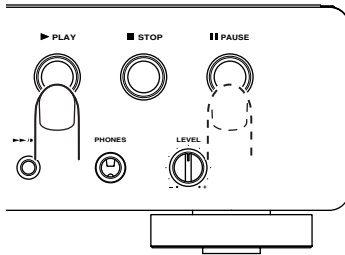

3. After A side program complete, player turns to the pause state at the beginning of B side program.
4. When A side of the tape ends up, Reverse cassette tape or invert recording direction manually and set to rec pause state.
5. Press **▶** or **⏸** buttons of the player manually to start B side recording. Player sends out signal to restart recording and starts playing B side program after 4 seconds.

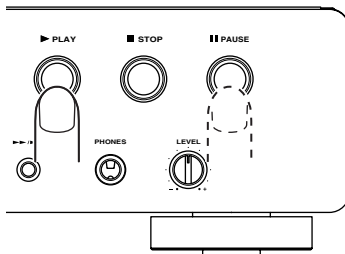

6. After B side program complete, player stops playing and clears edit program automatically.

- **Recording with Marantz cassette deck without remote cable connection, and recording with the cassette deck other than Marantz.**

1. After setting up Edit program, start recording of cassette deck first.
2. Press **▶** or **⏸** buttons of the player to start A side program. Then player starts playing A side program after 4 seconds.

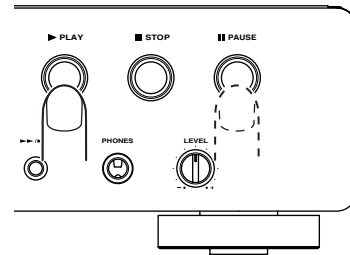

3. After A side program complete, player turns to the pause state at the beginning of B side program.
4. When A side of the tape ends up, Reverse cassette tape or invert recording direction manually and start recording.
5. Press **▶** or **⏸** buttons of the player to start B side recording. Then player starts playing B side program after 4 seconds.

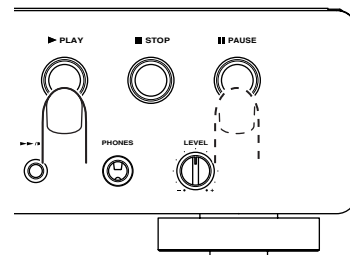

6. After B side program complete, player stops playing and clears edit program automatically.

Pitch control (changing the play speed)

The play speed (pitch) can be changed across a ± 12 step.

* Digital signals are not output during pitch control.

• Increasing the play speed

Press the PITCH+ button on the remote control unit.

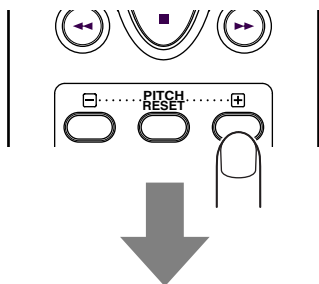

The "PITCH" indicator on the display lights. Each time the button is pressed, the play speed is increased, and it is displayed on the main display.

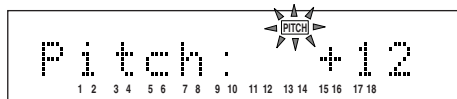

• Reducing the play speed

Press the PITCH- button on the remote control unit.

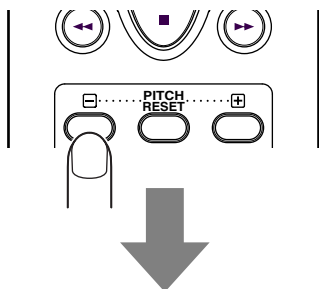

The "PITCH" indicator on the display lights. Each time the button is pressed, the play speed is reduced and it is displayed on the main display.

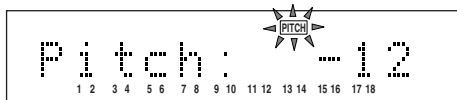

• Returning play to the normal speed

Press the PITCH RESET button on the remote control unit.

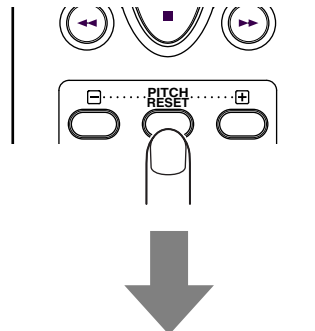

The "PITCH" indicator on the display goes off and "Pitch: 0" appears on the main display.

If the PITCH RESET button on the remote control unit is pressed again, play returns to the previous speed setting.

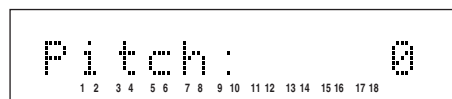

8. OTHER FUNCTIONS

CD-TEXT

“CD-TEXT” refers to a new kind of music disc which differs from a conventional music disc in that album titles, track titles and other text information are recorded on it. CDs with the following logos support this function.



The text information is recorded on those parts which were not used by conventional music CDs. This means that discs with recorded CD-TEXT can be played in the same way as in the past on existing CD players but the text information can be viewed only when they are played on a player that supports CD-TEXT. This player automatically identifies whether a disc supports CD-TEXT, and it displays the information on the display.

Display of player

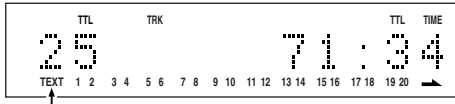

This lights when the disc that has been read is identified as supporting CD-TEXT.

The following items of the text information on CD-TEXT discs can be displayed in sequence by pressing the TEXT button on the remote control unit. However, the recorded information differs from one disc to another so that not all the information given below will necessarily be displayed. Items not recorded are automatically omitted and skipped by the player, and only the existing items are displayed.

• During play

Each time the TEXT button on the remote control unit is pressed, the information items are displayed in the following sequence. During play, the information of track now playing is mainly displayed.

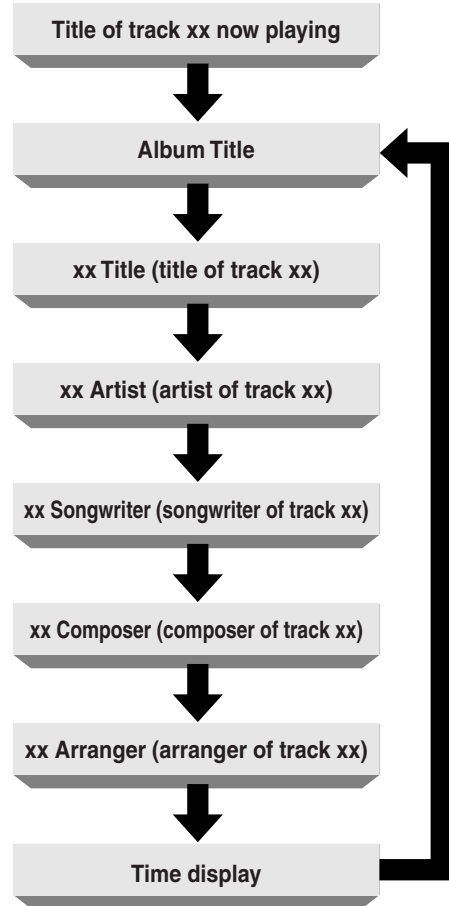

• In the stop mode

Each time the TEXT button on the remote control unit is pressed, the information items are displayed in the following sequence. When the ► button is pressed while “-- Title” is displayed, the track concerned starts playing. The maximum of characters that can be displayed is 64.

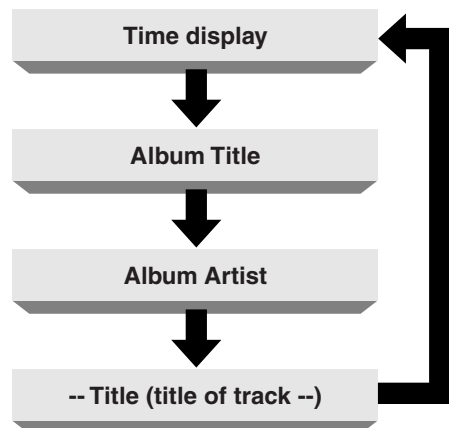

9. SPECIFICATIONS AND DIMENSIONS

Specifications

Audio characteristics

Channels 2 channels
Frequency response 2 Hz to 20 kHz
Dynamic range 100 dB
Signal-to-noise ratio 110 dB
Channel separation 100 dB (1 kHz)
Harmonic distortion 0.0025% (1 kHz)
Wow & flutter Precision of quartz
Error correction system Cross-interleave Reed
Solomon code (CIRC)
Audio output 2.0 V rms, stereo
Headphone output 18 mW/32 ohms (variable maximum)
Digital output
Coaxial output (pin jack) 0.5 Vp-p, 75 ohms
Optical output (square optical connector) -19 dBm

Optical readout system

Laser AlGaAs semiconductor
Wavelength 780 nm

Signal system

Sampling frequency 44.1 kHz
Quantization 16-bit linear/channel

Power supply

N, T version AC 230 V 50 Hz
Power consumption 12 W

Cabinet, etc.

Maximum dimensions 440(W) x 89(H) x 317 (D) mm
Weight 3.7kg
Allowable operating temperature +5 to +35°C
Allowable operating humidity 5 to 90% (no condensation)

This player's specifications and exterior are subject to change without notice for improvements.

Dimensions (unit: mm)

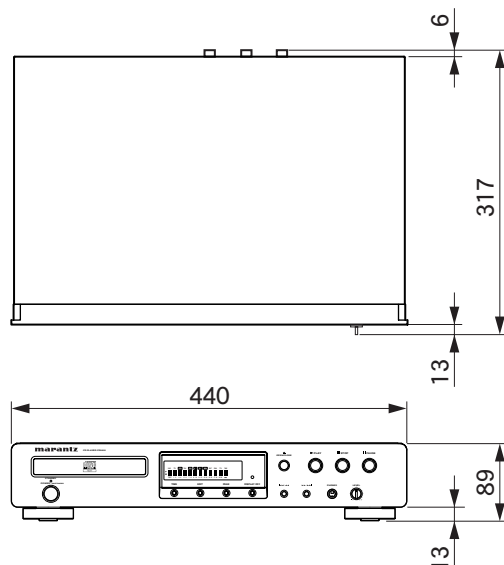

10. TROUBLESHOOTING

If you think that something is wrong with your player, first check the points listed below. Incorrect operations can sometimes be taken for trouble and malfunctions. If the trouble persists even after the following points have been checked, consult your dealer or nearest Marantz sales office or service center.

Disc fails to turn.

- Has the power cord been connected properly?
- Has the player's power been turned on?
- Has the disc been placed in the proper position?
- Is the disc upside down? (Is the disc's label surface facing up?)
- Is the disc dirty?
- Is the disc scratched?
- Is the disc warped?

Disc turns but no sound is heard.

- Have the amplifier and speakers been connected properly?
- Has the amplifier's power been turned on?
- Has the amplifier's function or selector switch been set to "CD" or "AUX" (or to whichever connectors the player has been connected)?
- Is the amplifier's volume at its lowest setting?

Disc starts turning but then stops at some point.

- Is the disc dirty?
- Is the disc scratched?
- Is the disc warped?
- Is the disc being played a music CD? CD-ROMs for personal computers, etc. cannot be played.

No remote control operations.

- Is the transmitter of the remote control unit (RC5400CD) pointed at the remote sensor of the player? Is there anything between the player and remote control unit which is blocking the signals?
- Have the batteries of the remote control unit (RC5400CD) run down?
- Is a strong light shining on the remote sensor of the player?
- Is the REMOTE CONTROL switch on the rear panel set to the EXTERNAL position? (Set it to the INTERNAL position if the player is to be used on its own.)

CD-R/CD-RW discs cannot be played.

- Has the disc been placed upside down on the disc tray?
- Is the recorded information in a format (CD-DA) used for music applications?
- Has the disc been finalized? If it is not finalized (closed), it cannot be played.

www.marantz.com

You can find your nearest authorized distributor or dealer on our website.

JAPAN	Marantz Japan, Inc.	35-1 Sagami Ohno 7-Chome, Sagamihara-shi, Kanagawa 228-8505, Japan
U.S.A.	Marantz America, Inc.	1100 Maplewood Drive, Itasca, IL 60143, U.S.A.
EUROPE	Marantz Europe B.V.	P.O. Box 8744, 5605 LS Eindhoven, The Netherlands

marantz[®] is a registered trademark.

